

# Acer c500 Series Pocket PC Travel Companion

User Manual

Copyright © 2006. Acer Incorporated.  
All Rights Reserved.

Acer c500 Series User Manual Version 019  
Original Issue: September 2006

Changes may be made periodically to the information in this publication without obligation to notify any person of such revisions or changes. Such changes will be incorporated in new editions of this User Manual or supplementary documents and publications. Acer makes no representations or warranties, either expressed or implied, with respect to the contents hereof and specifically disclaims the implied warranties of merchantability or fitness for a particular purpose.

Record the model number, serial number, purchase date and place of purchase information in the space provided below. The serial number and model number are recorded on the label affixed to your Acer c500 Series. All correspondence concerning your unit should include the serial number, model number, and purchase information.

No part of this publication may be reproduced, stored in a retrieval system, or transmitted, in any form or by any means, electronically, mechanically, by photocopy, recording or otherwise, without the prior written permission of Acer Incorporated.

Acer c500 Series Pocket PC Travel Companion

Model number: \_\_\_\_\_

Serial number: \_\_\_\_\_

Date of purchase: \_\_\_\_\_

Place of purchase: \_\_\_\_\_

Acer and the Acer logo are registered trademarks of Acer Incorporated. Other companies' product names or trademarks are used herein for identification purposes only and belong to their respective companies.

Microsoft, ActiveSync, Outlook, Outlook Mobile, Internet Explorer Mobile, Windows Media Player Mobile, Windows, Windows NT and the Windows logo are either registered trademarks or trademarks of Microsoft Corporation in the United States and/or other countries. Microsoft products are licensed to OEMs by Microsoft Licensing, Inc., a wholly owned subsidiary of Microsoft Corporation.

Acer and its subsidiaries make no representations or warranties, either expressed or implied, with respect to the contents hereof and specifically disclaims the implied warranties of merchantability or fitness for a particular purpose. Acer and its subsidiaries assume no responsibility for any damage or loss resulting from the use of this Acer c500 Series User Manual.

# Information for your safety and comfort

## Safety instructions

Read these instructions carefully. Keep this document for future reference. Follow all warnings and instructions marked on the product.

### Turning the product off before cleaning

Unplug this product from the wall outlet before cleaning. Do not use liquid cleaners or aerosol cleaners. Use a damp cloth for cleaning.

Unplug this product during lightning storms or when unused for long periods of time.

### CAUTION for Accessibility

Be sure that the power outlet you plug the power cord into is easily accessible and located as close to the equipment operator as possible. When you need to disconnect power to the equipment, be sure to unplug the power cord from the electrical outlet.

### CAUTION for Dummy Card of SD memory card slot

Your PDA shipped with plastic dummies installed in the SD memory card slot. Dummies protect unused slots from dust, metal object, or other particles. Save the dummy for use when no SD memory card is installed in the slot.

## Warnings

- Do not use this product near water.
- Do not place this product on an unstable cart, stand or table. If the product falls, it could be seriously damaged.
- Slots and openings are provided for ventilation to ensure reliable operation of the product and to protect it from overheating. These openings must not be blocked or covered. The openings should never be blocked by placing the product on a bed, sofa, rug or other similar surface. This product should never be placed near or over a radiator or heat register, or in a built-in installation unless proper ventilation is provided.
- Never push objects of any kind into this product through cabinet slots as they may touch dangerous voltage points or short-out parts that could result in a fire or electric shock. Never spill liquid of any kind onto or into the product.
- To avoid damage of internal components and to prevent battery leakage, do not place the product on a vibrating surface.
- Never use it under sporting, exercising, or any vibrating environment which will probably cause unexpected short current or damage devices, and even exposure risk from lithium battery pack.

### CAUTION for Listening

To protect your hearing, follow these instructions.

- Increase the volume gradually until you can hear clearly and comfortably.
- Do not increase the volume level after your ears have adjusted.
- Do not listen to music at high volumes for extended periods.
- Do not increase the volume to block out noisy surroundings.
- Decrease the volume if you can't hear people speaking near you.

## Using electrical power

- This product should be operated from the type of power indicated on the marking label. If you are not sure of the type of power available, consult your dealer or local power company.
- Do not allow anything to rest on the power cord. Do not locate this product where people will walk on the cord.
- Do not overload a power outlet, strip or receptacle by plugging in too many devices. The overall system load must not exceed 80% of the branch circuit rating. If power strips are used, the load should not exceed 80% of the power strip's input rating.

## Product servicing

Do not attempt to service this product yourself, as opening or removing covers may expose you to dangerous voltage points or other risks. Refer all servicing to qualified service personnel.

Unplug this product from the wall outlet and refer servicing to qualified service personnel when:

- the plug is damaged, cut or frayed
- liquid was spilled into the product
- the product was exposed to rain or water
- the product has been dropped or the case has been damaged
- the product exhibits a distinct change in performance, indicating a need for service
- the product does not operate normally after following the operating instructions



.....

**Note:** Adjust only those controls that are covered by the operating instructions, since improper adjustment of other controls may result in damage and will often require extensive work by a qualified technician to restore the product to normal condition.

## Battery

This product uses a Lithium-Ion battery. Do not use it in a humid, wet and/or corrosive environment. Do not put, store or leave your product in or near a heat source, in a high temperature location, in strong direct sunlight, in a microwave oven or in a pressurized container, and do not expose it to temperatures over 60°C (140°F). Failure to follow these guidelines may cause the Lithium-Ion battery to leak-acid, become hot, explode or ignite and cause injury and/or damage. Do not pierce, open or disassemble the battery. If the battery leaks and you come into contact with the leaked fluids, rinse thoroughly with water and seek medical attention immediately. For safety reasons, and to prolong the lifetime of the battery, charging will not occur at low (below 0°C/32°F) or high (over 40°C/104°F) temperatures.

## Replacing the battery pack

The PDA uses lithium batteries. Replace the battery with the same type as that which came bundled with your product. Use of another battery may present a risk of fire or explosion.



.....

**Warning! Batteries may explode if not handled properly. Do not disassemble or dispose of them in fire. Keep them away from children. Follow local regulations when disposing of used batteries.**

## Telephone line safety

- Disconnect all telephone lines from the equipment when not in use and/or before servicing.
- To avoid the remote risk of electric shock from lightning, do not connect the telephone line to this equipment during lightning or thunderstorms.



.....

**Warning! For safety reasons, do not use non-compliant parts when adding or changing components. Consult your reseller for purchase options.**

## Additional safety information

Your device and its enhancements may contain small parts. Keep them out of the reach of small children.

## Operating environment



**Warning!** For safety reasons, turn off all wireless or radio transmitting devices when using your laptop under the following conditions. These devices may include, but are not limited to: wireless lan (WLAN), Bluetooth and/or 3G.

Remember to follow any special regulations in force in any area, and always switch off your device when its use is prohibited or when it may cause interference or danger. Use the device only in its normal operating positions. This device meets RF exposure guidelines when used normally, and it and its antenna are positioned at least 1.5 centimeters (5/8 inches) away from your body (refer to the figure below). It should not contain metal and you should position the device the above-stated distance from your body. To successfully transmit data files or messages, this device requires a good quality connection to the network. In some cases, transmission of data files or messages may be delayed until such a connection is available. Ensure that the above separation distance instructions are followed until the transmission is completed. Parts of the device are magnetic. Metallic materials may be attracted to the device, and persons with hearing aids should not hold the device to the ear with the hearing aid. Do not place credit cards or other magnetic storage media near the device, because information stored on them may be erased.

## Medical devices

Operation of any radio transmitting equipment, including wireless phones, may interfere with the functionality of inadequately protected medical devices. Consult a physician or the manufacturer of the medical device to determine if they are adequately shielded from external RF energy or if you have any questions. Switch off your device in health care facilities when any regulations posted in these areas instruct you to do so. Hospitals or health care facilities may be using equipment that could be sensitive to external RF transmissions..

**Pacemakers.** Pacemaker manufacturers recommend that a minimum separation of 15.3 centimeters (6 inches) be maintained between wireless devices and a pacemaker to avoid potential interference with the pacemaker. These recommendations are consistent with the independent research by and recommendations of Wireless Technology Research. Persons with pacemakers should do the following:

- Always keep the device more than 15.3 centimeters (6 inches) from the pacemaker
- Not carry the device near your pacemaker when the device is switched o. If you suspect interference, switch off your device, and move it.

**Hearing aids.** Some digital wireless devices may interfere with some hearing aids. If interference occurs, consult your service provider.

## Vehicles

RF signals may affect improperly installed or inadequately shielded electronic systems in motor vehicles such as electronic fuel injection systems, electronic antiskid (antilock) braking systems, electronic speed control systems, and air bag systems. For more information, check with the manufacturer, or its representative, of your vehicle or any equipment that has been added. Only qualified personnel should service the device, or install the device in a vehicle. Faulty installation or service may be dangerous and may invalidate any warranty that may apply to the device. Check regularly that all wireless equipment in your vehicle is mounted and operating properly. Do not store or carry flammable liquids, gases, or explosive materials in the same compartment as the device, its parts, or enhancements. For vehicles equipped with an air bag, remember that air bags inflate with great force. Do not place objects, including installed or portable wireless equipment in the area over the air bag or in the air bag deployment area. If in-vehicle wireless equipment is improperly installed, and the air bag inflates, serious injury could result. Using your device while flying in aircraft is prohibited. Switch off your device before boarding an aircraft. The use of

wireless teledevices in an aircraft may be dangerous to the operation of the aircraft, disrupt the wireless telephone network, and may be illegal.

## Global Positioning System

The Global Positioning System (GPS) is a satellite-based system that provides location and timing information around the globe. GPS is operated and controlled under the sole responsibility of the national government authority which is responsible for its availability and accuracy. Any changes in GPS availability and accuracy, or in environmental conditions, may impact the operation of your device. Acer cannot accept any liability for the availability and accuracy of GPS.

## Use with Care

Use of this GPS device for navigation still means that you need to drive with due care and attention.

## Mounting on a Car

Extreme care must be taken when mounting ACER C500 on a car. Read the description in "**Set up the Acer c500 Series Pocket PC Travel Companion in your vehicle**" on page 24 carefully before mounting. ACER C500 shall be mounted in compliance with the relevant legislation and the vehicle manufacturer's rule. Failure to mount Acer c500 correctly could result in damage to your vehicle and serious injury to the vehicle rider and other road users. ACER C500 is mounted on your car at your own risk.

## Potentially explosive environments

Switch off your device when in any area with a potentially explosive atmosphere and obey all signs and instructions. Potentially explosive atmospheres include areas where you would normally be advised to turn off your vehicle engine. Sparks in such areas could cause an explosion or fire resulting in bodily injury or even death. Switch off the device at refueling points such as near gas pumps at service stations. Observe restrictions on the use of radio equipment in fuel depots, storage, and distribution areas; chemical plants; or where blasting operations are in progress. Areas with a potentially explosive atmosphere are often, but not always, clearly marked. They include below deck on boats, chemical transfer or storage facilities, vehicles using liquefied petroleum gas (such as propane or butane), and areas where the air contains chemicals or particles such as grain, dust or metal powders.

## Emergency calls

**Warning:** You cannot make emergency calls through this device. To make an emergency call you shall dial out through your mobile phone or other telephone call system.

## Disposal instructions

Do not throw this electronic device into the trash when discarding. To minimize pollution and ensure utmost protection of the global environment, please recycle. For more information on the Waste from Electrical and Electronics Equipment (WEEE) regulations, visit <http://global.acer.com/about/sustainability.htm>



## Mercury advisory

For projectors or electronic products containing an LCD/CRT monitor or display:

Lamp(s) inside this product contain mercury and must be recycled or disposed of according to local, state or federal laws. For more information, contact the Electronic Industries Alliance at [www.eiae.org](http://www.eiae.org). For lamp-specific disposal information, check [www.lamprecycle.org](http://www.lamprecycle.org).



## Tips and information for comfortable use

Computer users may complain of eyestrain and headaches after prolonged use. Users are also at risk of physical injury after long hours of working in front of a computer. Long work periods, bad posture, poor work habits, stress, inadequate working conditions, personal health and other factors greatly increase the risk of physical injury.

Incorrect computer usage may lead to carpal tunnel syndrome, tendonitis, tenosynovitis or other musculoskeletal disorders. The following symptoms may appear in the hands, wrists, arms, shoulders, neck or back:

- numbness, or a burning or tingling sensation
- aching, soreness or tenderness
- pain, swelling or throbbing
- stiffness or tightness
- coldness or weakness

If you have these symptoms, or any other recurring or persistent discomfort and/or pain related to computer use, consult a physician immediately and inform your company's health and safety department.

The following section provides tips for more comfortable computer use.

### Finding your comfort zone

Find your comfort zone by adjusting the viewing angle using a footrest, or raising your sitting height to achieve maximum comfort. Observe the following tips:

- refrain from staying too long in one fixed posture
- avoid slouching forward and/or leaning backward
- stand up and walk around regularly to remove the strain on your leg muscles
- take short rests to relax your neck and shoulders
- avoid tensing your muscles or shrugging your shoulders
- install the external display, keyboard and mouse properly and within comfortable reach
- if you view your monitor more than your documents, place the display at the center of your desk to minimize neck strain

### Taking care of your vision

Long viewing hours, wearing incorrect glasses or contact lenses, glare, excessive room lighting, poorly focused screens, very small typefaces and low-contrast displays could stress your eyes. The following sections provide suggestions on how to reduce eyestrain.

#### Eyes

- Rest your eyes frequently.
- Give your eyes regular breaks by looking away from the monitor and focusing on a distant point.
- Blink frequently to keep your eyes from drying out.

#### LCD Display

- Keep your display clean.
- Adjust the display brightness and/or contrast to a comfortable level for enhanced text readability and graphics clarity.

- Eliminate glare and reflections by:
  - placing your display in such a way that the side faces the window or any light source
  - minimizing room light by using drapes, shades or blinds
  - using a task light
  - changing the viewing angle
  - using a glare-reduction filter
- Avoid adjusting your display to an awkward viewing angle.
- Avoid looking at bright light sources, such as open windows, for extended periods of time.

### Developing good work habits

Develop the following work habits to make your computer use more relaxing and productive:

- Take short breaks regularly and often.
- Perform some stretching exercises.
- Breathe fresh air as often as possible.
- Exercise regularly and maintain a healthy body.



.....

**Note:** For more information, please refer to "Appendix A: Regulation & safety notices" on page 33.



# About this User Manual

---

Welcome to the Acer c500 Series User Manual. This User Manual is designed to help you get up and running quickly with your new Acer c500 Series — a Microsoft® Windows® Mobile 5.0 travel companion. It describes all you need to know about how to use your Acer c500 Series as well as the application programs that come with it.

This User Manual will address the following topics:

- A tour of the Acer c500 Series system
- Setup and maintenance procedures
- Taking advantage of your Acer c500 Series' expansion features
- Synchronizing data between your Acer c500 Series and your computer
- Connecting your Acer c500 Series to a computer, a network or the Internet
- Personalizing your Acer c500 Series with your own preference settings

This User Manual introduces you to the many ways your Acer c500 Series can help you organize and manage both business and personal information to make your everyday activities more productive and satisfying.

# First things first

We would like to thank you for making the Acer c500 Series your choice for meeting your travel companion needs. Your sleek new Acer c500 Series is a multi-functional tool packed with user-friendly features and high-performance applications that make organizing work-related information and synchronizing it with your personal activities an easy, efficient task. We hope you enjoy using your Acer c500 Series as much as we enjoyed creating it for you.

To effectively manage both business and personal information, your Acer c500 Series lets you:

- Install software and new applications.
- Use the Microsoft® Windows® Mobile 5.0 software to perform organizing and computing tasks.
- Synchronize the information on your computer with the information on your Acer c500 Series using Microsoft® ActiveSync®.
- Get connected to the Internet with Microsoft® Internet Explorer Mobile.
- Create an on-the-go backup file.
- Expand your Acer c500 Series' capabilities using the built-in SD/MMC slot.
- Exchange information between devices that have Bluetooth® / WLAN (optional) capabilities.
- Find your destination with the built-in GPS navigation system.
- Customize your Acer c500 Series based on your personal requirements and preferences.

**NOTE:** Design and specifications are subject to change without notice.

## Your guides

To help you use your Acer c500 Series, we have designed a set of guides:

| For information on:  | Refer to:  |
|--|--|
| Programs on your Acer c500 Series  | This User Manual. Bundled in the Acer c500 Series Companion CD, it provides online reference for using your Acer c500 Series.<br>The Acer c500 Series Help. To view Help, tap  and then <b>Help</b> . |
| Programs on your Acer c500 Series and additional programs that can be installed on your Acer c500 Series | The Acer c500 Series Companion CD.   |

| For information on:                                    | Refer to:   |
|--|---|
| Connecting to and synchronizing with your computer     | The Acer c500 Series Quick Guide. ActiveSync Help on your computer. To view Help, click <b>Help</b> and then <b>Microsoft ActiveSync Help</b> . |
| Last-minute updates and detailed technical information | The Read Me files. Located in the Microsoft ActiveSync folder on your computer and on the Acer c500 Series Companion CD.                        |
| Up-to-date information regarding your Acer c500 Series | <a href="http://www.acer.com/">http://www.acer.com/</a>   |
| Service Enquiries                                      | <a href="http://global.acer.com/support/index.htm">http://global.acer.com/support/index.htm</a>   |

## Package contents

Your Acer c500 Series comes packed in a cardboard box. Carefully unpack the box and remove the contents. If any of the following items are missing or damaged, contact your dealer immediately:

- Acer c500 Series
- Stylus
- Mini USB sync cable (USB to mini USB)
- AC adaptor
- Car charger
- Car cradle
- Car pedestal
- Safety drive notice
- Acer c500 Series Quick Guide
- Acer c500 Series Companion CD
- End-User License Agreement
- International Travelers Warranty
- Standard battery pack
- Pouch
- External GPS antenna (by model)
- GPS map SD card (by model)
- GPS map CD x 3 (by model)
- GPS software quick guide (by model)
- GNS TMC receiver (TMC module and antenna) (by model)

### Optional

- Mini USB sync cable
- AC adaptor kit
- Car charger
- Car mount kit
- External GPS antenna
- Screen protector
- Stylus pack
- Standard battery pack
- High capacity battery pack kit
- Leather cover
- Sun shade cover

## Taking care of your Acer c500 Series

- 1 Take care not to scratch the screen of your Acer c500 Series. Keep the screen clean.
- 2 Your Acer c500 Series is not waterproof and should not be exposed to rain or moisture.
- 3 Be careful not to drop your Acer c500 Series or subject it to any strong impact. Do not place your Acer c500 Series in your back pocket.
- 4 Protect your Acer c500 Series from extreme temperatures.
- 5 Do not use or store your Acer c500 Series in any location that is dusty, damp or wet.
- 6 Use a soft, moist cloth to clean your Acer c500 Series.

## Maintaining your Acer c500 Series

This section provides information on the following:

- Proper care and usage of your Acer c500 Series
- Resetting your Acer c500 Series

### Proper care and usage of your Acer c500 Series

Your Acer c500 Series' solid construction is designed to provide you with years of reliable, trouble-free service. Observing the following general maintenance procedures will help ensure this:

- 1 Take care not to scratch the screen of your Acer c500 Series. Keep the screen clean. When working with your Acer c500 Series, use the supplied stylus or plastic-tipped pens intended for use with touch-sensitive screens. Never use an actual pen or pencil or other sharp object on the screen surface.
- 2 Your Acer c500 Series is not waterproof and should not be exposed to rain or moisture. Do not let water enter the circuitry through the front panel buttons or expansion slots. In general, treat your Acer c500 Series as you would a pocket calculator or other small electronic device.
- 3 Take care not to drop your Acer c500 Series or subject it to any strong impact. Do not place your Acer c500 Series in your back pocket; if you sit on it, you may damage it.
- 4 Protect your Acer c500 Series from temperature extremes. For example, do not leave your Acer c500 Series on the dashboard of a car on a hot day or when temperatures are below freezing point. Also, keep it away from heaters and other sources of heat.
- 5 Do not use or store your Acer c500 Series in any location that is dusty, damp or wet.

- 6 Use a soft, damp cloth to clean your Acer c500 Series. If the surface of the screen becomes soiled, clean it with a soft cloth moistened with diluted window-cleaning solution.

## Resetting your Acer c500 Series

You may have to perform a reset if your Acer c500 Series no longer responds to the buttons on the screen.

### Performing a soft reset

A soft reset allows your Acer c500 Series to get a fresh start, similar to rebooting a computer. All records and entries are retained after a soft reset.

To perform a soft reset:

- Using the tip of your stylus, lightly press the **Reset** button inside the hole on the upper right-hand side of your Acer c500 Series.



### Performing a hard reset

A hard reset will erase all records and entries stored in your Acer c500 Series. Never perform a hard reset unless a soft reset does not correct your problem. When you perform your next ActiveSync operation, you can restore any data that you previously synchronized to your computer. To perform a hard reset:

- 1 Press and hold the **Today** and **Messaging (a)** buttons on your Acer c500 Series.

- 2 While holding the **Calendar** and **Contacts** buttons, using the tip of your stylus, lightly press the **Reset** button inside the hole (b) on the upper right-hand side of your Acer c500 Series.

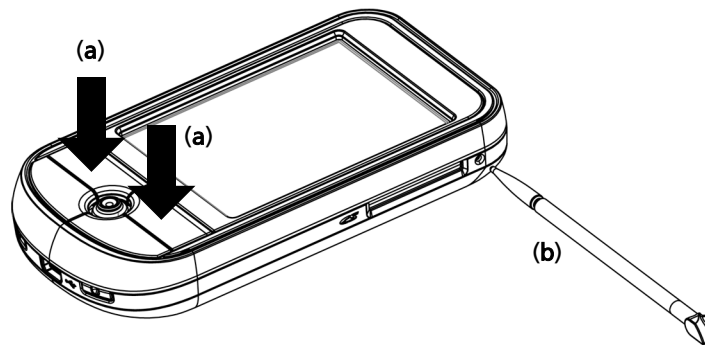

---

**NOTE:** When you perform a hard reset, formats, preferences and other settings including date and time are restored to their factory default settings. **All data, records and entries, except for those stored in ROM, will be erased.**

---

## Correct SD card usage

Do not remove the SD card or turn off the device while using applications.

Do not turn off the device or remove the SD card during route calculation.

It is strongly recommended that you close the navigation application upon arrival, before turning off the device. Failure to do so may cause system hangs.

# Contents

|  |           |
|--|-----------|
| Information for your safety and comfort        | i         |
| About this User Manual                         | vii       |
| First things first                             | viii      |
| Your guides                                    | viii      |
| Package contents                               | ix        |
| Taking care of your Acer c500 Series           | x         |
| Maintaining your Acer c500 Series              | x         |
| Proper care and usage of your Acer c500 Series | x         |
| Resetting your Acer c500 Series                | xi        |
| Correct SD card usage                          | xii       |
| <b>1 Getting started</b>                       | <b>1</b>  |
| System requirements                            | 1         |
| Features summary                               | 1         |
| Performance                                    | 1         |
| Display  | 2         |
| Audio  | 2         |
| USB connector                                  | 2         |
| Connectivity                                   | 2         |
| Expansion                                      | 2         |
| Battery  | 2         |
| Design and ergonomics                          | 3         |
| Acer c500 Series tour                          | 4         |
| Front view                                     | 4         |
| Rear view                                      | 5         |
| Left view                                      | 6         |
| Right view                                     | 7         |
| Top view                                       | 8         |
| Bottom view                                    | 8         |
| Preparing to use your Acer c500 Series         | 9         |
| Charging your Acer c500 Series                 | 9         |
| Insert the Battery                             | 9         |
| Charging using the AC adapter                  | 12        |
| Setting up your Acer c500 Series               | 13        |
| Installing the Microsoft® ActiveSync® software | 14        |
| Connecting the computer                        | 15        |
| Performing the first synchronization process   | 16        |
| Command interface                              | 18        |
| Acer c500 Series buttons and the stylus        | 18        |
| Start menu                                     | 18        |
| Online help                                    | 18        |
| <b>2 Backup and restore data</b>               | <b>20</b> |
| To launch Backup/Restore                       | 20        |
| Backup function                                | 20        |
| Restore function                               | 22        |

# Contents

---

|   |   |    |
|---|---|----|
| 3 GPS                                   |   | 24 |
|   | Set up the Acer c500 Series Pocket PC Travel Companion in your vehicle  | 24 |
| Appendix A: Regulation & safety notices |   | 33 |
|   | FCC notice  | 33 |
|   | Notice: Shielded cables   | 33 |
|   | Notice: Peripheral devices  | 33 |
|   | Caution   | 33 |
|   | Operation conditions  | 34 |
|   | Notice: Canadian users  | 34 |
|   | Remarque à l'intention des utilisateurs canadiens                       | 34 |
|   | Canada — Low-power license-exempt radio communication devices (RSS-210) | 34 |
|   | Declaration of Conformity for EU countries                              | 34 |
|   | LCD pixel statement   | 34 |
|   | Radio device regulatory notice  | 35 |
|   | General   | 35 |
|   | European Union (EU)   | 35 |
|   | List of applicable countries  | 35 |
|   | Federal Communications Commission Declaration of Conformity             | 36 |



# 1 Getting started

---

This chapter will address the following topics:

- Basic requirements
- Feature highlights of your Acer c500 Series
- Acer c500 Series system tour
- Step-by-step procedures on how to prepare your Acer c500 Series for use
- Basic concepts in using your Acer c500 Series

## System requirements

In order to install the Microsoft® ActiveSync® software and use your new Acer c500 Series with a computer at work or at home, be sure the system(s) meet the following minimum system and program requirements:

- Intel® Pentium® processor (minimum 233 MHz)
- 64 MB RAM
- 120 MB disk space
- CD-ROM drive
- USB port
- SVGA (or compatible) graphics card supporting 256 colors
- Microsoft® Windows XP or 2000
- Microsoft® Internet Explorer 4.01

## Features summary

### Performance

- Samsung 2442/300MHz (MSP3)
- System memory:
  - 64 MB SDRAM
  - 128 MB NAND Flash ROM
- Microsoft® Windows Mobile™ 5.0 with Outlook® Mobile

## Display

- 2.8" QVGA (Transmissive with micro reflective; TMR) with touch panel
- 240 x 320 resolution
- 65536 color support
- Microsoft® ClearType technology for clearer, crisper font display

## Audio

- Philips UDA1380 CODEC with CD-quality stereo output
- Industry-standard 3.5 mm stereo earphone jack, 3-ring type
- Mono speaker
- Unidirectional microphone

## USB connector

- 5 pin mini USB connector
- USB Slave, TMC (UART Port)
- DC power-in (5V, 1A)

## Connectivity

- Bluetooth® 2.0 EDR
- IEEE 802.11b/g WLAN (by model)
- SiRF Star III Low Power and High Sensitivity Chip

## Expansion

- SD/MMC slot (SDIO compatible)

## Battery

- High-density, rechargeable 1200 mAh Li-Ion battery (changeable)
- Battery life
  1. Normal usage with backlight on (default brightness), WLAN, Bluetooth and GPS off : 10 hours
  2. MP3 usage: with speaker: 19 hours
  3. Navigation software usage with backlight on and WLAN, Bluetooth off : 5 hours
  4. Normal usage with backlight and WLAN on, Bluetooth and GPS off : 4 hours

---

**NOTE:** Length of battery operation will depend on power consumption, which is based on system resource use. For example, constantly using the backlight or using power-demanding applications, using GPS or wireless, will shorten battery life between charges.

---

- 4-hour charging time from empty to full capacity

---

**NOTE:** To avoid data loss, please follow the correct procedure to power down the system, then replace the main battery with the backup battery within 30 minutes.

---

## Design and ergonomics

- Thin, light and stylish design

| Specifications | Dimensions                           |
|----------------|--------------------------------------|
| Height         | 108 mm                               |
| Width          | 58 mm                                |
| Depth          | 16.8 mm                              |
| Weight         | 122 g (including battery and stylus) |

- User-friendly navigation features
  - 5-way directional pad for one-hand operation
  - Quick buttons for easy launch of commonly used applications
  - Start  button for one-tap access to all available applications

## Acer c500 Series tour

### Front view

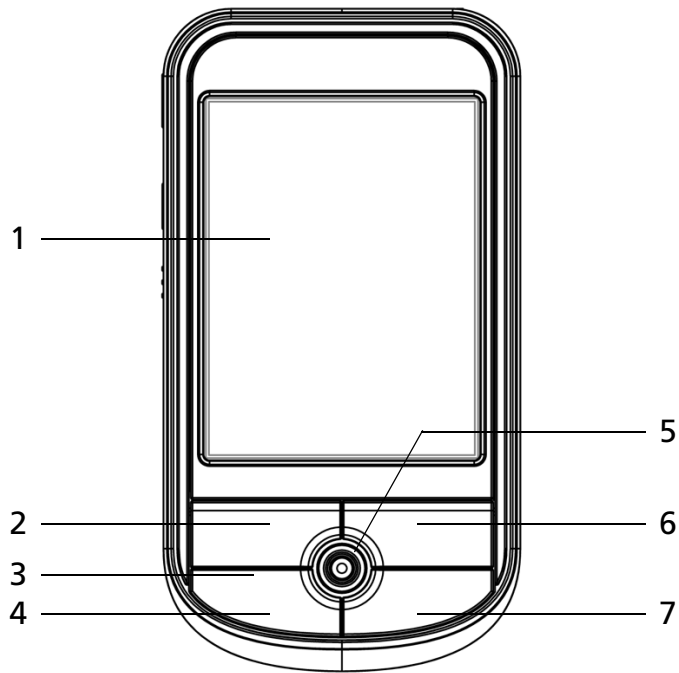

| No. | Component                  | Description   |
|-----|----------------------------|---|
| 1   | 2.8" TFT LCD               | Displays the applications and data stored in your Acer c500 Series.   |
| 2   | Quick button for Calendar  | Activates the Calendar program.   |
| 3   | Microphone                 | Inputs audio to your Acer c500 Series.  |
| 4   | Quick button for Today     | Displays the Today screen.  |
| 5   | Directional pad            | Enables 5-direction scrolling in various menus and applications. Press the center of the pad to simulate the function of the Enter key. |
| 6   | Quick button for Contacts  | Activates the Contacts program.   |
| 7   | Quick button for Messaging | Activates the Messaging program.  |

---

**NOTE:** If your Acer c500 Series is turned off, pressing any Quick button turns it on and opens the program assigned to that button.

---

## Rear view

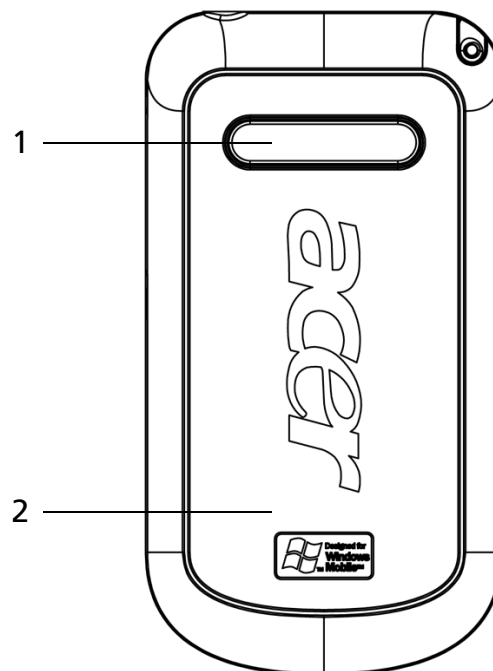

| No. | Component     | Description                                |
|-----|---------------|--|
| 1   | Speaker       | Outputs audio from your Acer c500 Series.  |
| 2   | Battery cover | Houses the Acer c500 Series' battery pack. |

## Left view

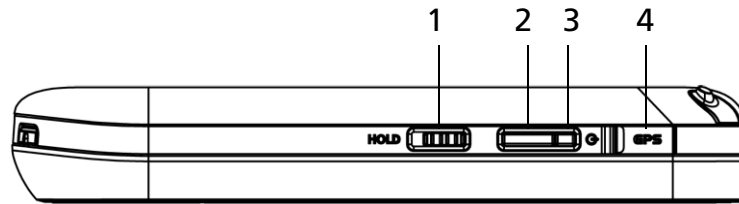

| No. | Label                          | Description  |
|-----|--------------------------------|--|
| 1   | Hold switch                    | Slide to lock all buttons from being accidentally pressed when Acer c500 Series is placed in pocket or bag. A red dot is visible on the hold switch when in hold state.  |
| 2   | Power button                   | Press to turn your Acer c500 Series on if it is off and return to the last screen that was displayed, or off if it is on.  |
| 3   | Power/Charging/Alarm indicator | Power LED indicator.<br>- Status description: <ul style="list-style-type: none"><li>• Flashing green — Charging</li><li>• Steady green — Charging complete</li><li>• Flashing red — Alarm indicator, email receiving</li></ul> |
| 4   | External GPS antenna connector | Connects to external GPS antenna (optional).   |

## Right view

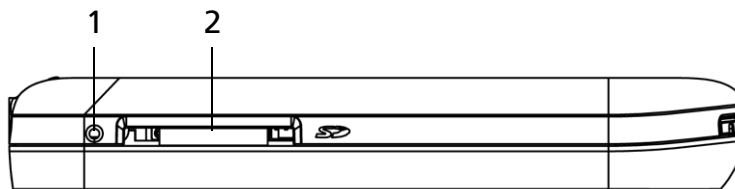

| No. | Label       | Description  |
|-----|-------------|--|
| 1   | Soft Reset  | Using the tip of your stylus, lightly press the reset button inside the hole on the right side of your Acer c500 Series.   |
| 2   | SD/MMC slot | Accepts a Secure Digital or MultiMedia Card, allowing you to add more memory, install add-on applications or use audio or text files stored on it with internal applications. You can also use expansion cards to back up data from your Acer c500 Series. |

## Using the backlight

If lighting conditions make it difficult for you to see the information on your Acer c500 Series, use the backlight to illuminate your screen.

To activate the backlight:

- Press the power button and hold it down for about two seconds. Release the button when the backlight turns on.
- To turn off the backlight, press the power button and hold it down for two seconds. Release the button when the backlight turns off.

### Top view

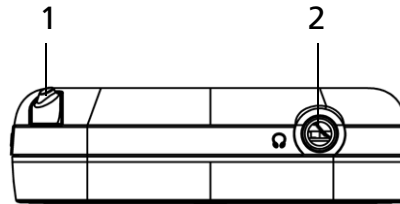

| No. | Label         | Description   |
|-----|---------------|---|
| 1   | Stylus holder | Secures the stylus to your Acer c500 Series. To use the stylus, remove from its holder and hold it as you would hold a pen or pencil. |
| 2   | Earphone jack | Connects to audio line-out devices (earphones).   |

### Bottom view

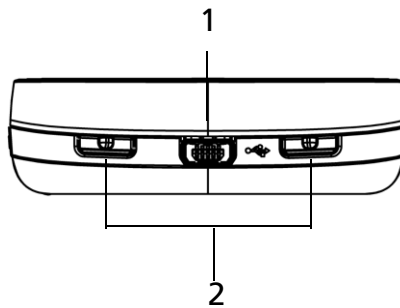

| No. | Label               | Description  |
|-----|---------------------|--|
| 1   | mini USB connector  | Connects your Acer c500 Series to a portable or desktop computer, and DC power supply to an AC wall outlet to charge the battery.<br>- USB client<br>- DC power-in |
| 2   | Battery cover clips | Unlatch the battery cover to remove the battery pack.  |



## Preparing to use your Acer c500 Series

The following easy installation tasks let you begin using your Acer c500 Series:

- Installing the Microsoft® ActiveSync® software in your computer
- Connecting the computer
- Charging your Acer c500 Series
- Setting up your Acer c500 Series
- Performing the first ActiveSync operation

## Charging your Acer c500 Series

For initial use, you need to charge your Acer c500 Series for 4 hours. After that, you can charge it for a few minutes each day to recharge the battery to full capacity. Normally, you can use your Acer c500 Series for 8 straight hours of operation (backlight inactive) before you need to recharge the battery.

### Insert the Battery

Insert the battery pack into the battery bay, then place the battery cover on top of this, making sure that the battery release clips clip into place.

(Image shown is face down)

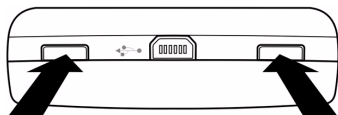

Press in on both battery release clips at the same time with a pen or similar object. Do NOT use the stylus to do this.

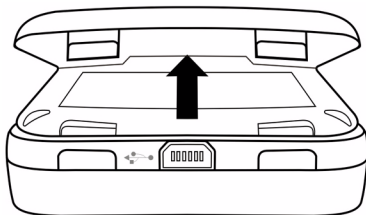

Lift the battery cover off.

# 1 Getting started

## Charging your Acer c500 Series

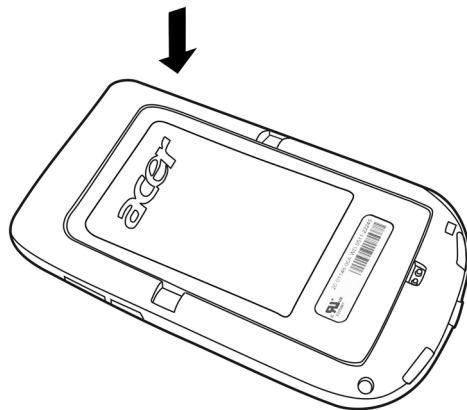
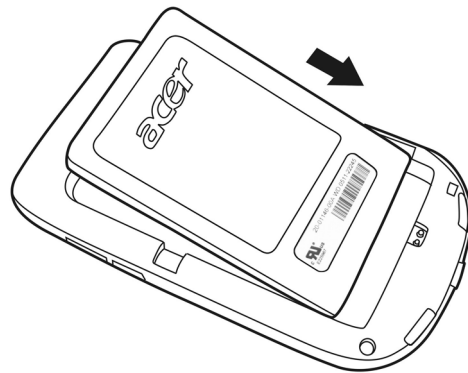
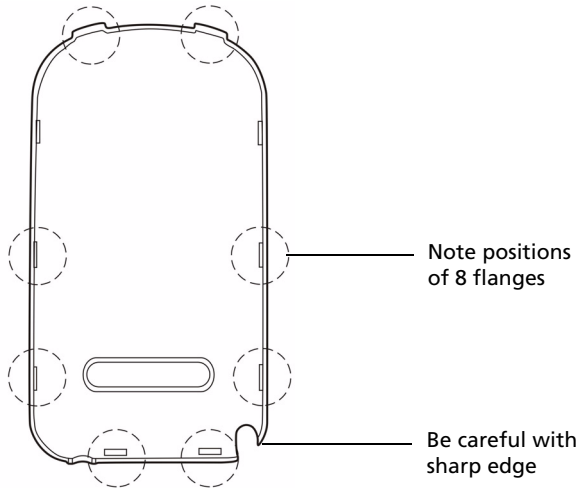

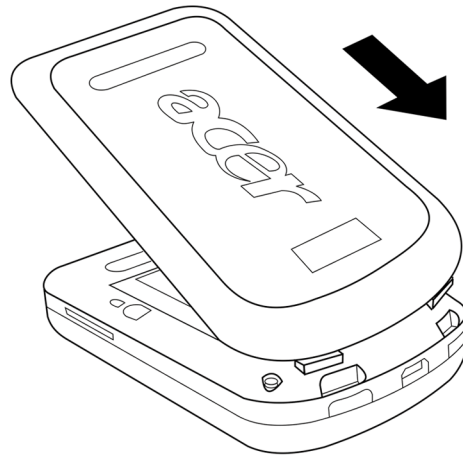

Angle the battery cover as shown in the diagram and make sure that the two battery cover clips are correctly placed before proceeding to the next step.

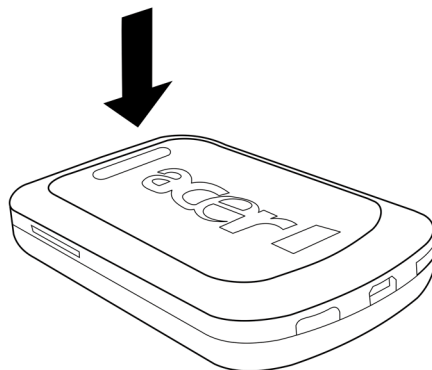

Press down on the battery cover and make sure that all 8 flanges clip into place.

## Charging using the AC adapter

- 1 Connect the AC adapter cord to the mini USB connector on the bottom of your Acer c500 Series.
- 2 Plug the AC adapter into any AC current outlet and charge the device for at least 4 hours.

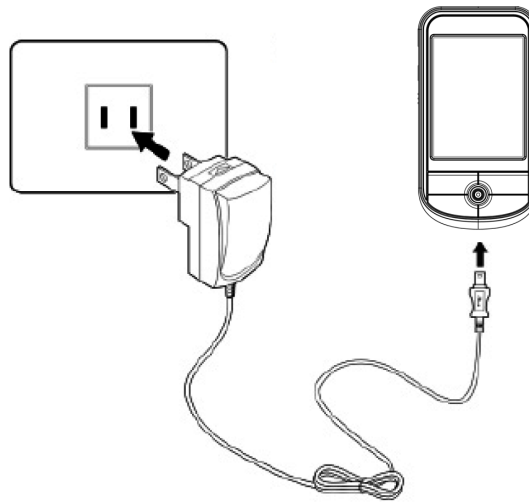

Power LED status during charging:

- Charging — LED indicator flashes green
- Charging complete — LED indicator steady green

If the battery level becomes low in the course of normal use, a status icon appears on the Acer c500 Series screen indicating low or very low battery status. Perform an ActiveSync operation to back up your data; then recharge the battery.

## Setting up your Acer c500 Series

After you have initially charged your Acer c500 Series for 4 hours, you can now set it up. Refer to the instructions below.

### To set up your Acer c500 Series

- 1 Disable the hold switch (found on the left side of your Acer c500 Series) by moving it up to the unlocked position. See **"Left view"** on page 6 for the location of the hold switch.
- 2 Turn on your Acer c500 Series by pressing the power button on the left side. See **"Left view"** on page 6 for the location of the power button.

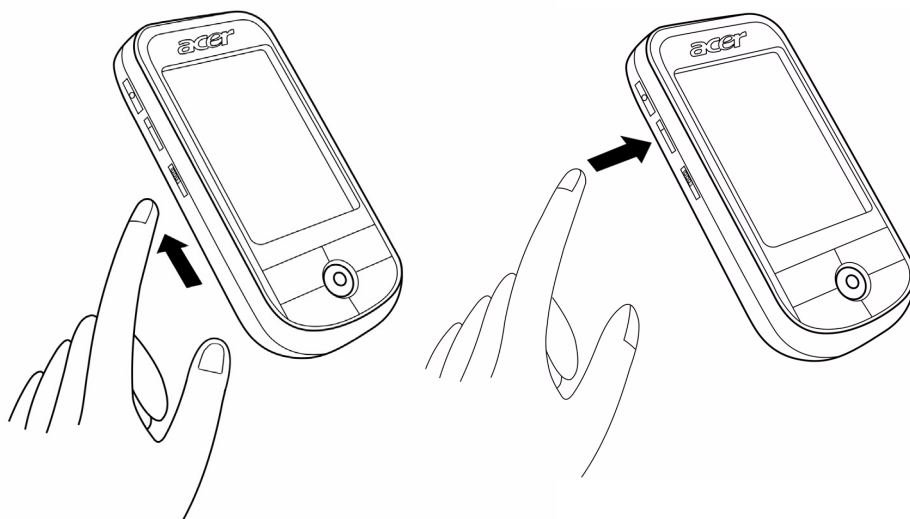

- 3 Follow the onscreen instructions to set up your Acer c500 Series.

To begin using the GPS function, please refer to chapter 3 and to the Navigation Software quick guide (by model).

## Installing the Microsoft® ActiveSync® software

The main function of the Microsoft® ActiveSync® software is to synchronize the information on your computer with the information on your Acer c500 Series. Synchronization compares the data on your Acer c500 Series with your computer and updates the information on both locations. This will then serve as backup data in case something happens to your Acer c500 Series.

The following instructions tell you how to install the ActiveSync® software.

### Important installation notes

- Before installing ActiveSync, make sure that your Acer c500 Series is not yet connected to your computer. Connect the Acer c500 Series after you have finished installing ActiveSync.
- If you don't have Microsoft® Outlook® 98 or later installed, please install Microsoft® Outlook® 2002 now. Even if you have Outlook 98 or Outlook 2000 installed, you are encouraged to upgrade to Outlook 2002.
- It is recommended that users install Outlook 2002 from this CD before installing ActiveSync.
- Do not copy the ActiveSync files to your computer's hard disk. You must use the Acer c500 Series Companion CD to place the files in their proper locations and to decompress the files.

### To install the Microsoft® ActiveSync® software

- 1 Exit any open programs, including those that run at startup, and disable any virus-scanning software.
- 2 Insert the Acer c500 Series Companion CD into the computer's CD-ROM drive. The CD's welcome page appears.
- 3 Click the animated forward icon to go to the next screen.
- 4 Please follow the instructions to install Microsoft® Outlook® 2002 and Microsoft® ActiveSync® 4.2.

After installation, the ActiveSync® icon  will appear on your computer's system tray (on the lower right-hand corner of the screen).

Refer to the ActiveSync® software online Help for information on how to use the software. If at any time, you would like to restart this setup program, simply re-insert the CD into the CD-ROM drive.

## Connecting the computer

The mini USB sync cable that comes with your Acer c500 Series enables you to synchronize the information on your Acer c500 Series with the data in your computer using ActiveSync technology.

### To connect the computer

- 1 Plug the mini USB sync cable into the mini USB connector on the bottom of your Acer c500 Series.
- 2 Plug the USB client connector into an available USB port on your computer.

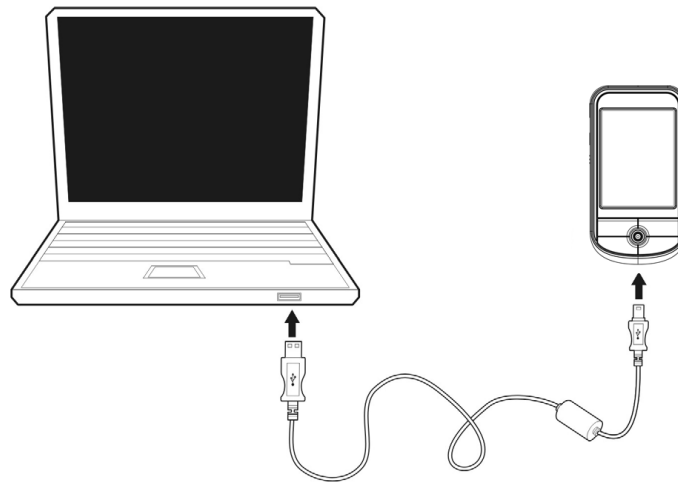

## Performing the first synchronization process

After completing the setup procedures, you can now perform the first ActiveSync operation with the help of the New Partnership setup wizard.



This wizard will help you:

- Set up a partnership so you can synchronize information between your Acer c500 Series and your computer
- Customize your synchronization settings



### To perform the first synchronization process

- 1 Connect the mini USB sync cable to your Acer c500 Series.
- 2 Plug the USB client connector into a USB port on your computer.  
The 'New Partnership' setup wizard will automatically start on your computer screen.

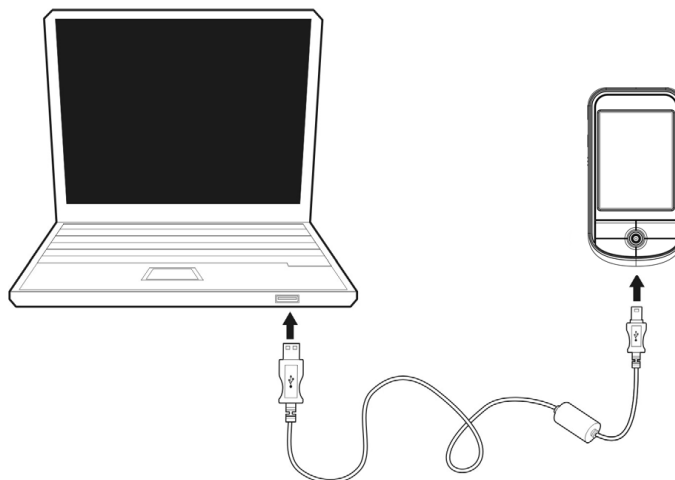

---

**NOTE:** If the wizard does not automatically appear, launch ActiveSync on your computer by clicking on its icon from **Start>Programs**.

---

- 3 Follow the onscreen instructions.

The first synchronization process will automatically begin when you finish using the wizard.

After your first synchronization, take a look at Calendar, Contacts and Tasks on your Acer c500 Series. You'll notice that information you've stored in Microsoft Outlook on your computer has been copied to your Acer c500 Series, and you don't have to type a word. Disconnect your Acer c500 Series from your computer and you're ready to go!

Once you have set up ActiveSync and completed the first synchronization process, you can initiate synchronization from your Acer c500 Series. To switch to ActiveSync on your Acer c500 Series, tap , and then tap **ActiveSync**.

## Command interface

### Acer c500 Series buttons and the stylus

Your Acer c500 Series has hardware buttons that control actions and scroll functions, and a stylus for selecting items and entering information.

On your Acer c500 Series, the stylus replaces the mouse.

- Tap: Touch the screen once with the stylus to open items and select options.
- Drag: Hold the stylus on the screen and drag across the screen to select text and images. Drag in a list to select multiple items.
- Tap and hold: Tap and hold the stylus on an item to see a list of actions available for that item. On the pop-up menu that appears, tap the action you want to perform.

### Start menu

From the Start menu, you can select programs, settings and Help topics. To display the Start menu, from the top of any screen tap .

### Online help

Refer to online Help for information on how to use the applications embedded. Please press  >Help>Content for online help.

You can find information about the following Microsoft® applications.





- Outlook® Mobile - Organize personal information: calendar, contacts, tasks, notes and messaging
- Word™ Mobile - Word processing application compatible with Microsoft® Word
- Excel™ Mobile - Spreadsheet application compatible with Microsoft® Excel
- PowerPoint™ Mobile - View presentation slides (compatible with Microsoft® PowerPoint)
- Windows® Media™ Player 10 Mobile - Play back multimedia files: MP3, Windows® Media audio, Windows® Media video, and streaming video files
- Internet Explorer Mobile - Browse websites and download files and images
- Calculator - Easy-to-use calculator
- Games - Enjoy playing classic Solitaire and Bubble Breaker.
- File Explorer - Manage files in main memory or on storage media cards
- Microsoft® ActiveSync® 4.2 - Synchronize PIM data with Microsoft® Outlook®
- Pictures & Videos - View pictures and videos
- Lunar View - View the Chinese lunar calendar (for Chinese OS version)
- Pocket MSN - Provide instant access to your Hotmail account, and MSN Messenger Contacts list

- Terminal Services Client - Run applications or remotely manage a server from the Acer c500 Series





If you need Help for any specific application, launch the application and then tap  >Help for online help.

You can use your handheld to exchange information with mobile devices, your computer, a network, or the Internet. If you need more information on Bluetooth® or Wireless LAN (optional):

#### Bluetooth® Help

- Turn Bluetooth® on by tapping  >Turn Bluetooth® on>  >Bluetooth® Manager or Bluetooth® Settings>  >Help for Bluetooth® help.
- Or you can tap  >Help>Contents>Setting Up Connections for more Bluetooth® information.

#### Wireless LAN Help (by model)

- Turn Wireless LAN on by tapping  >Turn WLAN on>  >WLAN Utility>  >Help for WLAN help.
- Or you can tap  >Help>Contents>Setting Up Connections or Browsing the Web for more information.

# 2 Backup and restore data

Backup/Restore enables you to back up data files and applications from your Acer c500 Series to a storage device and to restore data to your Acer c500 Series. Advanced security features offer password protection of sensitive documents/applications during Backup and/or Restore operations. The expansion features of your Acer c500 Series allow you to use any of the following storage devices:

- SD Card (Secure Digita Card)
- MMC card

Please do not press any button, including the power button, during a backup or restore operation.

There are two tabs (from left to right) in the program window corresponding to the two functions of Backup and Restore.

- Backup
- Restore

## To launch Backup/Restore

- 1 Insert a storage device (SD/MMC card) if you want to do backup/restore operation on a storage device.
- 2 Tap  Programs, and then **Backup/Restore**.

## Backup function

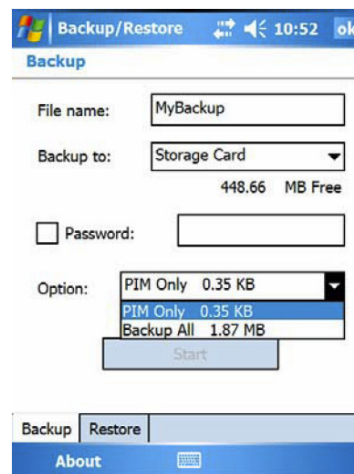

### To perform data backup

- 1 Close all running programs except for Backup/Restore.
- 2 In the Backup tab, choose whether to accept the default filename (MyBackup) or type a new one by tapping on the keyboard icon on the bottom of the screen.
- 3 Select a storage device from the 'Backup to' pull-down menu.
- 4 Define the backup scope (default: PIM only) from the 'Option' pull-down menu.
- 5 Check the password box and enter a password if you want to secure the backup file.
- 6 Tap  to proceed with the backup process.  
During the backup process, a progress screen will appear displaying backup status.
- 7 When the backup process is completed, a message box appears, saying that backup operation is done.

## Restore function

You can only restore backup files that are generated by Backup/Restore; file format is \*.abk (Acer backup).

### To perform data restoration

- 1 Close all running programs except for Backup/Restore.
- 2 Select a source storage device from the 'Restore from' pulldown menu.

The lower half of the screen will display a list of files contained in the selected storage device. Filename, file size and date when the backup file was created are indicated in the list.

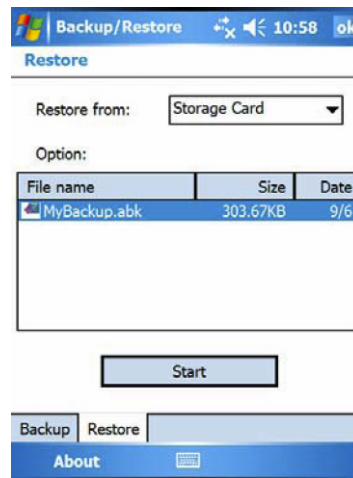

- 3 Tap a filename to select the file you wish to restore, and please note that non-.abk files are not shown.

Select file, then tap . The window will shift to display the backup file information including:

- File name — filename of the selected .abk file.
- Backup date — date when the selected .abk file was created.
- Backup option & file size.
- Main memory free size - free space in your Acer c500 Series' main storage memory. This should be bigger than the file size of the selected .abk file for the restore process to continue.

- 4 Tap  again to proceed with the restore process.
- 5 During the restore process, a progress screen will appear displaying restore status.
- 6 When the restore process is completed, a message box appears, saying restore operation is complete.

### To delete a file from a storage device

To increase the size of available free space in a storage device, you can delete files that you no longer need.

- 1 Tap the **Restore** tab.
- 2 Tap a menu item to select a storage device.
- 3 From the list, tap a filename until a delete pop-up menu is displayed.
- 4 Tap **Delete** to remove the file.

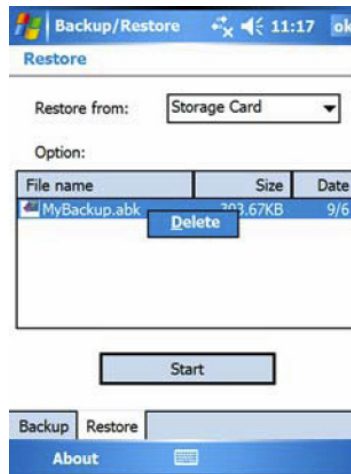

# 3 GPS

---

## Set up the Acer c500 Series Pocket PC Travel Companion in your vehicle

The Acer c500 Series comes with a car pedestal and a car charger with which you can set up your device in your vehicle. You can choose to position the car pedestal on the windshield using the suction cup, or on the dashboard using the self adhesive disc connector.

---

**NOTE:** Switch off WLAN and Bluetooth before using the GPS navigation system.

---

**NOTE:** Some countries prohibit the mounting of any electronic device in any location on the vehicle dashboard. Be sure to check your local laws for acceptable mounting areas before installing the car mount bracket.

---

**NOTE:** Some newer vehicle models may have a heat reflective shield embedded in the windshield. This may in some cases obstruct the GPS signal reception. If you encounter this problem in your vehicle, you need to purchase an external GPS antenna. For more information, contact your local Acer dealer.

---

**NOTE:** It is strongly recommended that users remove their valuables when leaving the car, including this navigation device.

---

### Car pedestal installation reminders

Install the car pedestal on a surface of your vehicle:

- That is smooth, flat and free of dirt and oil
- Where the driver can easily view/reach it without taking his/her eyes too far off the road
- Where the device will not obscure car controls nor restrict the driver's view of the road
- Far from the air bag deployment area

### Set up the device in your vehicle

This section shows how to install the car pedestal in your vehicle's windshield using the suction cup.

- 1 Clean the mounting surface with a glass cleaner and a clean cotton cloth.
- 2 If the ambient temperature is below 15 °C (60 °F) warm the mounting area and the suction cup (e.g. with a hair dryer) to ensure a strong suction bond.
- 3 Install the car pedestal on the selected area.



*Set up the Acer c500 Series Pocket PC Travel Companion in your vehicle*

- Fix the suction cup to the selected area with the locking lever facing up (A).
- Flip the locking lever away from you to create a vacuum between the suction cup and the mounting surface (B).

**NOTE:** Images may differ from actual car pedestal or external GPS antenna depending on model and package.

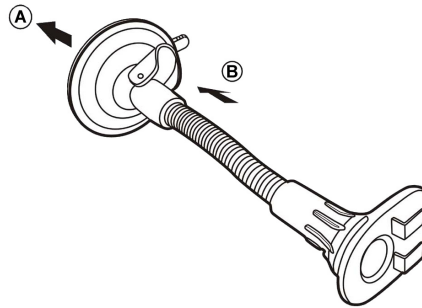

- Make sure that the suction bond is strong enough before proceeding to the next step.
- Feed the car charger cable down the back of the car cradle.

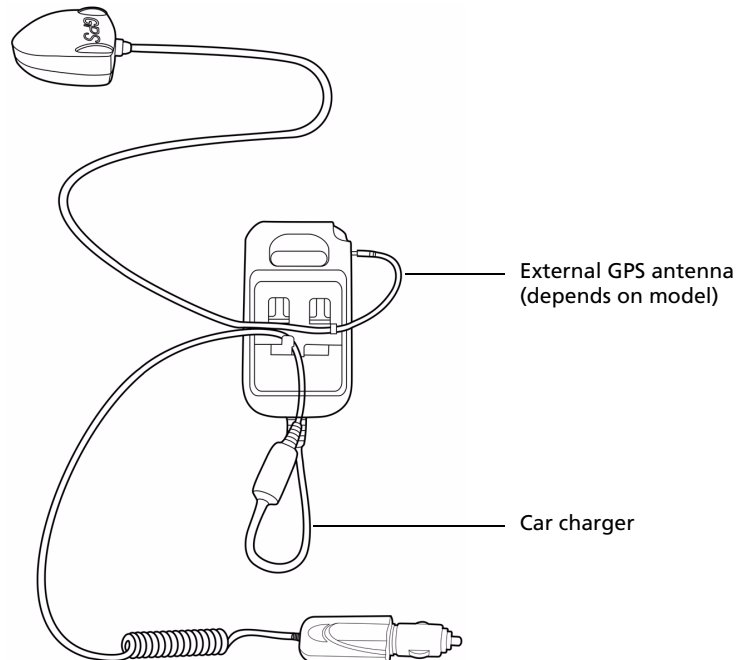

- Insert the pegs on the car pedestal's holder plate to the holes on the back of the car cradle (A), then move the car cradle until both parts are engaged (B).

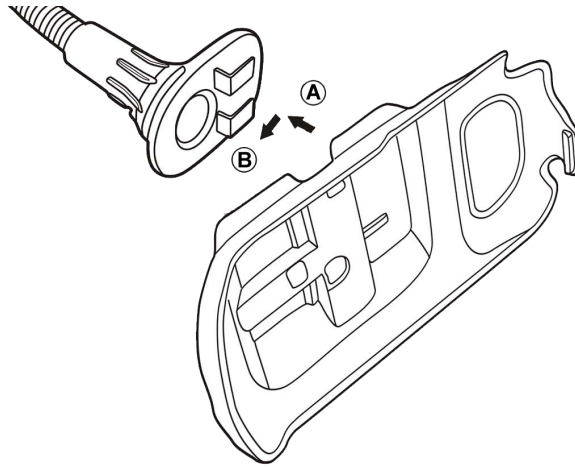

- 4 Insert the Navigation software SD card into the device.

---

**NOTE:** To remove the SD card, push it in a little and let it pop out.

---

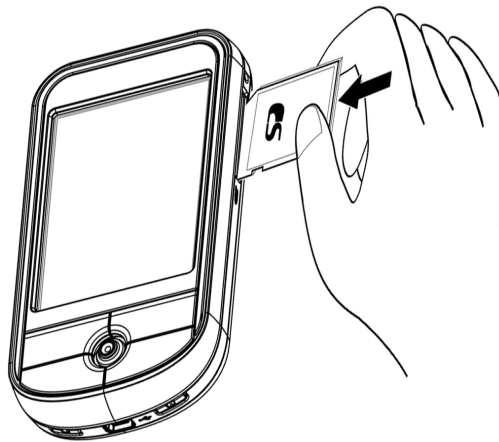

- 5 Dock the device on the car cradle

---

**NOTE:** To remove device from car cradle, push the upper tab up first.

---

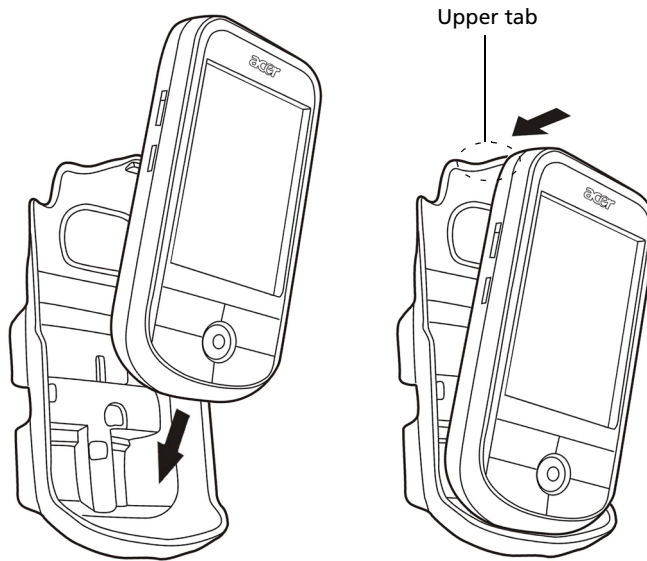

6 Adjust the car pedestal for the best viewing angle.

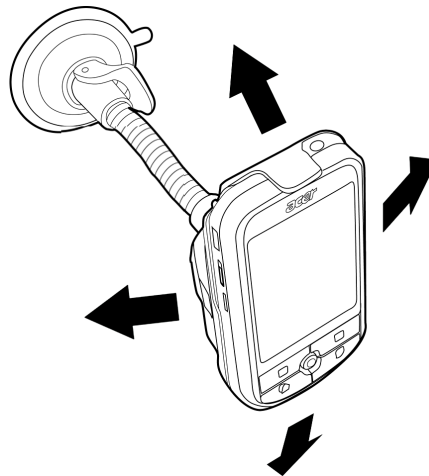

---

**NOTE:** Please operate the car pedestal with both hands (one hand holds the car pedestal and the other holds the car cradle) when adjusting. Be careful with the connecting point between the car pedestal and the car cradle, as otherwise they could become separated while adjusting.

---

### 3 GPS

#### Set up the Acer c500 Series Pocket PC Travel Companion in your vehicle

---

- 7 To get the best GPS performance, the device can be adjusted to a 45 degree angle of elevation, or mounted either vertically (portrait) or horizontally (landscape), as in the following image.

---

**NOTE:** Use both hands when adjusting the position. See note in step 6 for more information.

---

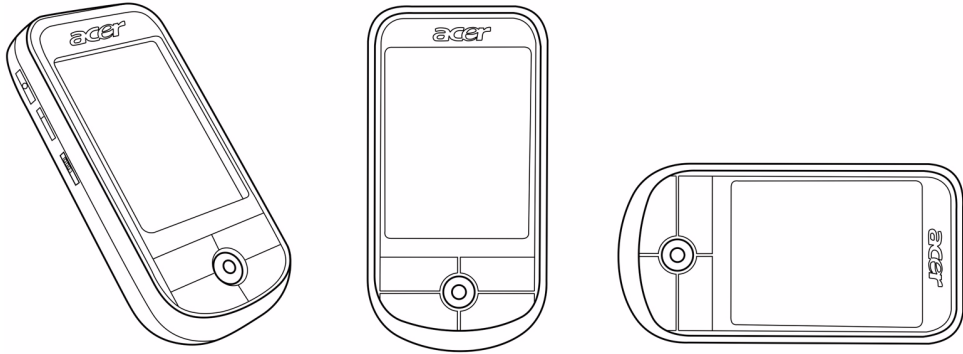

- 8 After setting up the device on the car pedestal, connect the car charger.

---

**NOTE:** For cable allocation, see "Feed the car charger cable down the back of the car cradle." on page 25

---

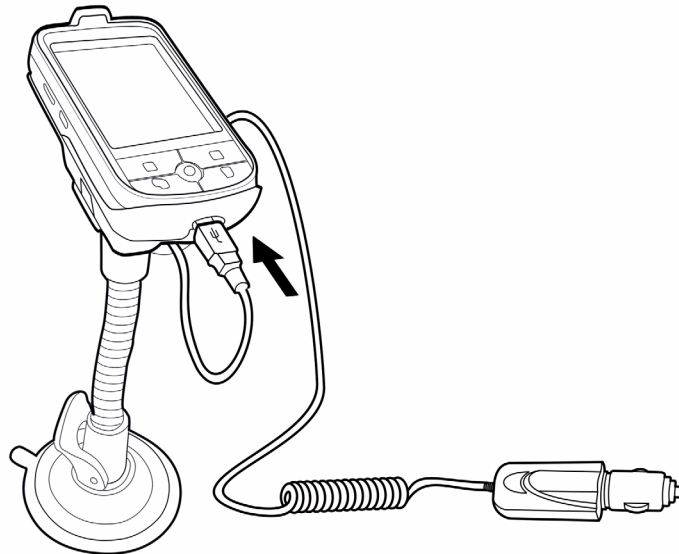

The power LED indicator flashes green during charging.

- For models which include the GNS TMC cable, please connect it to the car charger and the Acer c500 series.

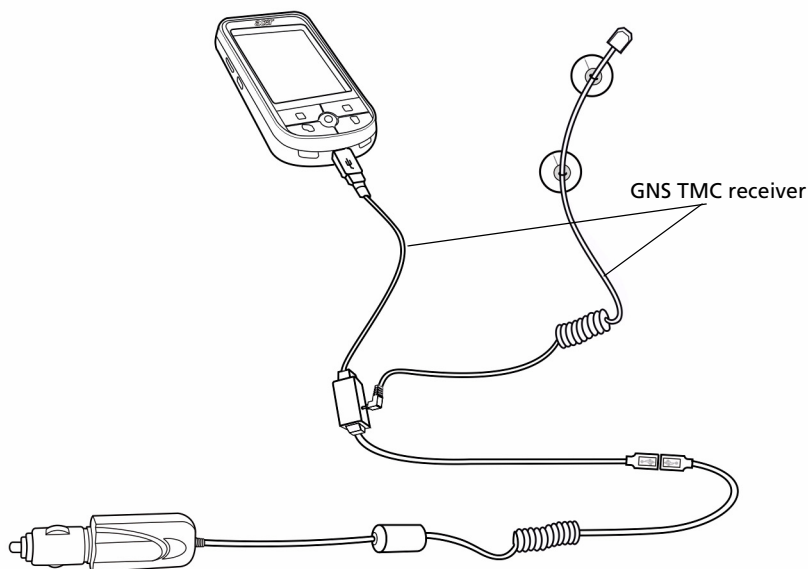

---

**NOTE:** The GNS TMC receiver is powered by the car charger, and must be connected to it in order to work with the c500 series.

---



---

**NOTE:** For information on using the GNS TMC receiver, refer to the Navigation software quick guide and user manual.

---



---

**NOTE:** If the car engine is turned off, you may be required to switch the vehicle ignition back into the Accessories position. Consult your vehicle owner's manual.

---



---

**NOTE:** You can start using the device once it is mounted in your vehicle and connected to the car charger. However, for maximum usage time you need to charge your device to full capacity. Go to "**Charging your Acer c500 Series**" on page 9 for instructions.

---

### 3 GPS

## Set up the Acer c500 Series Pocket PC Travel Companion in your vehicle

---

**NOTE:** If you wish to use the sun shade cover (optional), combine 1 and 2 first, then dock 3 onto 2 (See image below).

---

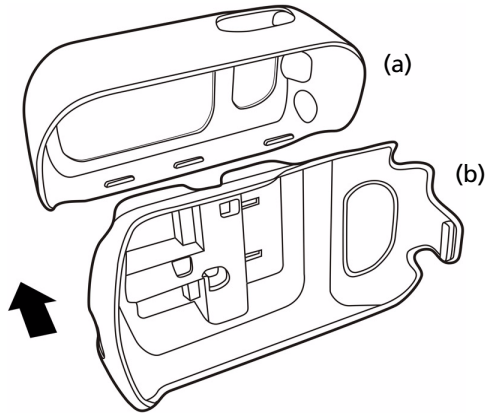

Combine the sunshade cover (a) and car cradle (b).

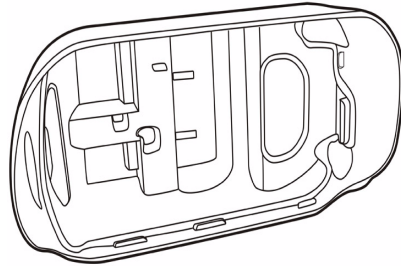

Combined sunshade cover and car cradle shown here.

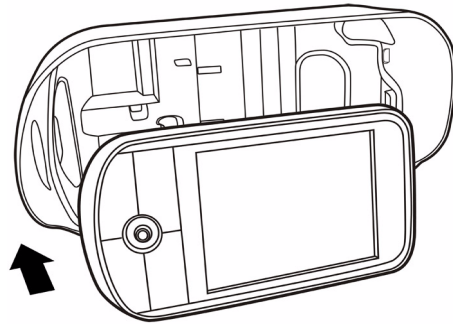

Dock the device

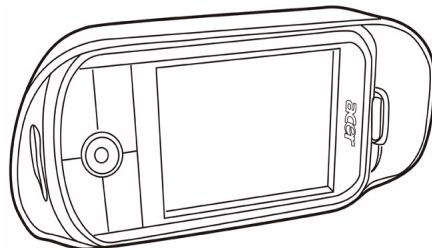

Docked device shown here.

Connect cable(s).

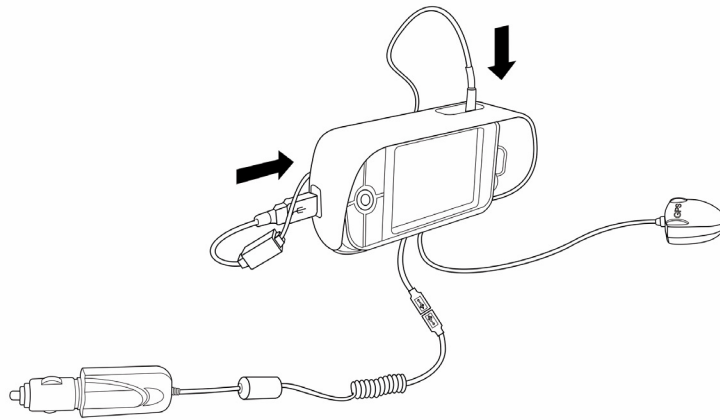

Connect the car pedestal.

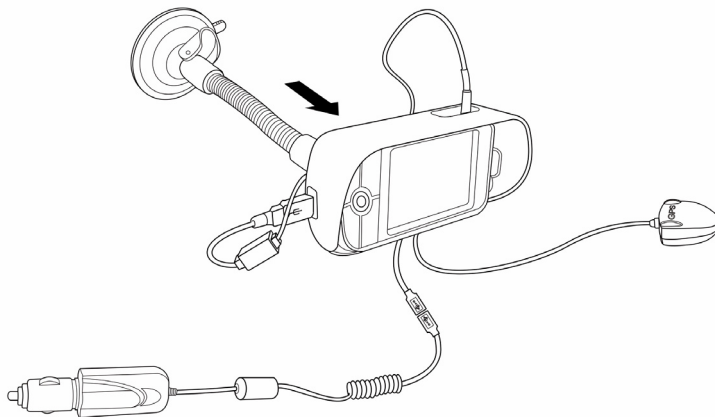

To remove the sunshade:

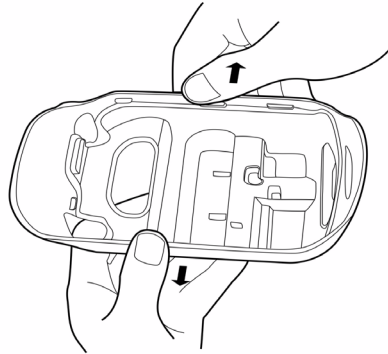

While pushing the back of the car cradle, gently bend the sides of the sunshade outwards.

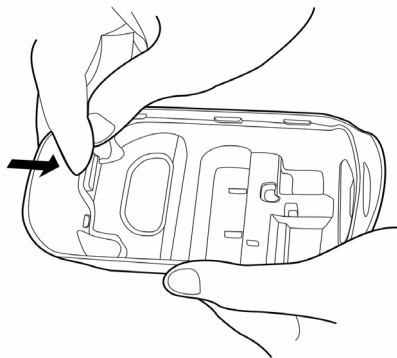

Pull the tab indicated in the diagram inwards and let the car cradle detach from the flanges.

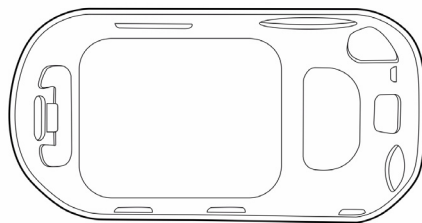

Separate the sunshade from the car cradle.

---

**NOTE:** To avoid risk of theft, remove all car pedestal components when leaving the car.

---

---

**NOTE:** For models bundled with Navigation software (depending on model), to begin using the Navigation function, please refer to the Navigation quick guide and the Navigation user manual on the Navigation software CD, or online help in the Navigation software.

---



# Appendix A: Regulation & safety notices

---

This appendix lists the general notices of your PDA.

## FCC notice

This device has been tested and found to comply with the limits for a Class B digital device pursuant to Part 15 of the FCC rules. These limits are designed to provide reasonable protection against harmful interference in a residential installation. This device generates, uses, and can radiate radio frequency energy and, if not installed and used in accordance with the instructions, may cause harmful interference to radio communications.

However, there is no guarantee that interference will not occur in a particular installation. If this device does cause harmful interference to radio or television reception, which can be determined by turning the device off and on, the user is encouraged to try to correct the interference by one or more of the following measures:

- Reorient or relocate the receiving antenna.
- Increase the separation between the device and receiver.
- Connect the device into an outlet on a circuit different from that to which the receiver is connected.
- Consult the dealer or an experienced radio/television technician for help.

### Notice: Shielded cables

All connections to other computing devices must be made using shielded cables to maintain compliance with FCC regulations.

### Notice: Peripheral devices

Only peripherals (input/output devices, terminals, printers, etc.) certified to comply with the Class B limits may be attached to this equipment. Operation with non-certified peripherals is likely to result in interference to radio and TV reception.

### Caution

Changes or modifications not expressly approved by the manufacturer could void the user's authority, which is granted by the Federal Communications Commission, to operate this computer.

## Operation conditions

This device complies with Part 15 of the FCC Rules. Operation is subject to the following two conditions: (1) this device may not cause harmful interference, and (2) this device must accept any interference received, including interference that may cause undesired operation.

## Notice: Canadian users

This Class B digital apparatus complies with Canadian ICES-003.

## Remarque à l'intention des utilisateurs canadiens

Cet appareil numérique de la classe B est conforme à la norme NMB-003 du Canada.

# Canada — Low-power license-exempt radio communication devices (RSS-210)

- a Common information  
Operation is subject to the following two conditions:
  - 1. This device may not cause interference, and
  - 2. This device must accept any interference, including interference that may cause undesired operation of the device.
- b Operation in 2.4 GHz band  
To prevent radio interference to the licensed service, this device is intended to be operated indoors and installation outdoors is subject to licensing.

## Declaration of Conformity for EU countries

Hereby, Acer, declares that this notebook PC series is in compliance with the essential requirements and other relevant provisions of Directive 1999/5/EC. (Please visit <http://global.acer.com/products/pda/reg/index.htm> for complete documents.)

Compliant with Russian regulatory certification



ME61

## LCD pixel statement

The LCD unit is produced with high-precision manufacturing techniques. Nevertheless, some pixels may occasionally misfire or appear as black or red dots. This has no effect on the recorded image and does not constitute a malfunction.

## Radio device regulatory notice

---

**NOTE:** Below regulatory information is for models with wireless LAN and/or Bluetooth only.

---

### General

This product complies with the radio frequency and safety standards of any country or region in which it has been approved for wireless use. Depending on configuration, this product may or may not contain wireless radio devices (such as wireless LAN and/or Bluetooth modules). Information below is for products with such devices.

### European Union (EU)

R&TTE Directive 1999/5/EC as attested by conformity with the following harmonized standard:

- **Article 3.1(a) Health and Safety**
  - EN60950-1:2001
  - EN50371:2002
- **Article 3.1(b) EMC**
  - EN301 489-1 V1.4.1:2002
  - EN301 489-17 V1.2.1:2002
- **Article 3.2 Spectrum Usages**
  - EN300 328 V1.5.1:2004

### List of applicable countries

EU member states as of May 2004 are: Belgium, Denmark, Germany, Greece, Spain, France, Ireland, Italy, Luxembourg, the Netherlands, Austria, Portugal, Finland, Sweden, United Kingdom Estonia, Latvia, Lithuania, Poland, Hungary, Czech Republic, Slovak Republic, Slovenia, Cyprus and Malta. Usage allowed in the countries of European Union, as well as Norway, Switzerland, Iceland and Liechtenstein. This device must be used in strict accordance with the regulations and constraints in the country of use. For further information, please contact local office in the country of use.

## Federal Communications Commission Declaration of Conformity

This device complies with Part 15 of the FCC Rules. Operation is subject to the following two conditions: (1) This device may not cause harmful interference, and (2) This device must accept any interference received, including interference that may cause undesired operation.

The following local manufacturer/importer is responsible for this declaration:

|                               |   |
|-------------------------------|---|
| Product name:                 | PDA   |
| Model number:                 | c500  |
| Machine type:                 | c500  |
| SKU number:                   | c5xxx ("x" = 0~9, a ~ z, or A ~ Z)                |
| Name of responsible party:    | Acer America Corporation                          |
| Address of responsible party: | 2641 Orchard Parkway<br>San Jose, CA 95134<br>USA |
| Contact person:               | Mr. Young Kim                                     |
| Tel:                          | 408-922-2909                                      |
| Fax:                          | 408-922-2606                                      |



**Acer Computer (Shanghai) Limited**  
3F, No. 168 Xizang medium road, Huangpu District,  
Shanghai, China



## Declaration of Conformity

We,  
**Acer Computer (Shanghai) Limited**  
3F, No. 168 Xizang medium road, Huangpu District,  
Shanghai, China

Contact Person: Mr. Easy Lai  
Tel: 886-2-8691-3089 Fax: 886-2-8691-3000  
E-mail: [easy\\_lai@acer.com.tw](mailto:easy_lai@acer.com.tw)

Hereby declare that:

|                      |   |
|----------------------|---|
| <b>Product:</b>      | <b>Travel Companion</b>                   |
| <b>Trade Name:</b>   | <b>Acer</b>                               |
| <b>Model Number:</b> | <b>c500</b>                               |
| <b>SKU Number:</b>   | <b>c5xxx ("x" = 0~9, a ~ z, or A ~ Z)</b> |

Is compliant with the essential requirements and other relevant provisions of the following EC directives, and that all the necessary steps have been taken and are in force to assure that production units of the same product will continue comply with the requirements.

**EMC Directive 89/336/EEC, amended by 92/31/EEC and 93/68/EEC as attested by conformity with the following harmonized standards:**

- EN55022:1998 + A1:2000 + A2:2003, AS/NZS CISPR22:2002, Class B
- EN55024:1998 + A1:2001 + A2:2003
- EN61000-3-2:2000, Class D
- EN61000-3-3:1995 + A1:2001

**Low Voltage Directive 73/23/EEC as attested by conformity with the following harmonized standard:**

- EN60950-1:2001

**RoHS Directive 2002/95/EC on the Restriction of the Use of certain Hazardous Substances in Electrical and Electronic Equipment**

**R&TTE Directive 1999/5/EC as attested by conformity with the following harmonized standard:**

- **Article 3.1(a) Health and Safety**
  - EN60950-1:2001
- **Article 3.1(b) EMC**
  - EN301 489-1 V1.4.1:2002
  - EN301 489-17 V1.2.1:2002
- **Article 3.2 Spectrum Usages**
  - EN300 328 V1.5.1:2004

*Easy Lai*  
\_\_\_\_\_  
Easy Lai Director  
Acer Computer (Shanghai) Limited

Aug. 28, 2006  
\_\_\_\_\_  
Date

# Index

## B

- backlight 5
- Backup
  - opening 20
  - Restore function 22

## C

- command interface 18
  - device buttons 18
  - Today screen 18

## F

- Features 1
  - audio 2
  - battery pack 2
    - install 9
  - connectivity 2
  - display 2
  - expansion 2

## G

- Guides viii

## M

- Maintenance x

## P

- Package contents ix
- Performance 1

## R

- Resetting xi

## S

- Setup
  - installing Microsoft ActiveSync software 14
  - initial synchronisation 16
- system tour 4
  - bottom view 8
  - front view 4, 5
  - left view 6
  - right view 7
  - top view 8

## T

- third-party applications
  - IA Album LE 23
- travel companion features
  - ergonomics 3